

m o o o i<sup>®</sup>



## Container Oval

---

by Marcel Wanders

A new versatile family member enters the Container Table series by Marcel Wanders. Available in the same materials & colours as its sibling, it combines soft, rounded shapes with a slender body: a dream of many.

---

<b>Designer</b>	Marcel Wanders
<b>Year of design</b>	2013
<b>Material</b>	Container Foot: PE, Top: Laquered Wood, Stained Wood, Linoak

---

m o o o i<sup>®</sup>

**Additional**

The feet should be filled with sand to create extra stability

---

## the container tops are available in the following materials and colours:



Oak veneer, stained and lacquered:

Thickness top 4cm | 1.6"

For indoor use only

Available in the 6 Moooi stain colours, and 25 Moooi Ral Colours



Linoak:

Thickness top, 4cm | 1.6"

For indoor use only

The solid oak edge is available in the 6 Moooi stain colours, the linoleum centre is available in Mauve, Pewter and Nero.

---

## The container feet are available in the following shapes and colours



Classic: White, Black



New Antiques: White, Black, Brown, Light-Grey





Bodhi Cover: Black, Cinnamon, Grey, Natural Oil, Wenge, White Wash

## Container General

The container table top range all attached to the container foot in the same way. The container concept is that sand, pebbles or water can be added to the foot to give it strength and stability. Water must always be treated with an anti-algae additive to prevent the water from becoming stale. There are Hex-bolts on the underside of each table which align with equally spaced holes in the container foot.

## Container Table Oval options

CONTAINER FAMILY						Top			FOOT	dining table	dining table
Shape	L	W	HPL	Wood	Linoak		7143	71x43cm   28x16.9"	7156	71x56cm   28x22.1"	
											<i>Classic</i>
											
<i>Bodhi</i>											
	7143	71x43cm   28"x16.9 "	7156	71x56cm   28x22.1"							
					<i>New Antiques</i>						
<i>Number of feet required</i>											
Oval	210cm   82.7"	135cm   53.1"		x	x					1	
Oval	260cm   102.4"	150cm   59.1"		x	x					2	

---

## Linoak

The center of the Linoak top is made of linoleum, and available in the following colours. The solid oak edge is available in one of the 6 moooi stain colours.



mauve



nero



pewter

---

## Stain colours

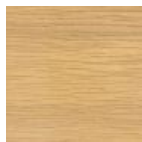

White Wash

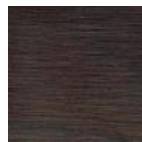

Wenge

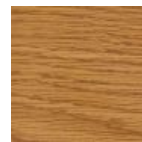

Natural Oil



Grey

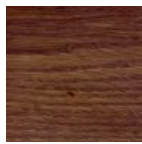

Cinnamon

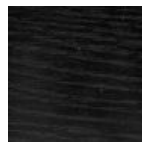

Black Stained

## Ral Colours

Available RAL Colours:

1004 1013 1023 1027 2000 2002 2004 3012 3015 5003 5008 5024 6010 6021 7001 7011 7035 7044 8001 8014 8016 9005 9010 9016 3003

	RAL 1004		RAL 1013		RAL 1023		RAL 1027
	RAL 2000		RAL 2002		RAL 2004		RAL 3003
	RAL 3012		RAL 3015		RAL 5003		RAL 5008
	RAL 5024		RAL 6010		RAL 6021		RAL 7001
	RAL 7011		RAL 7035		RAL 7044		RAL 8001
	RAL 8014		RAL 8016		RAL 9005		RAL 9010
	RAL 9016						

## cleaning instructions

Moooki recommends using a good furniture polish and a soft cloth. Apply generously in layers to the surface and use the cloth to shine. Do not use abrasive fabrics, gently remove tough stains with warm water and a trusted multi-surface cleaner.

---

## packaging

### **Bodhi Cover 7056**

H 68 cm | 26,8"

W 27 cm | 10,6"

D 27 cm | 10,6"

Colli 1/1

Product weight:

10 KG | 22 lb

With packaging:

12 KG | 26,5 lb

### **Container Table Foot 7056**

H 73 cm | 28,7"

W 57 cm | 22,4"

D 57 cm | 22,4"

Colli 1/1

Product weight:

13,5 KG | 29,8 lb

With packaging:

14,5 KG | 32 lb

### **Container, New Antiques 7156**

H 74 cm | 29,1"

W 60 cm | 23,6"

D 60 cm | 23,6"

Colli 1/1

Product weight:

12 KG | 26,5 lb

With packaging:

13 KG | 28,7 lb

---

## Packaging

### **Bodhi Cover 7043**

H 68 cm | 26,8"

W 22 cm | 8,7"

D 22 cm | 8,7"

Colli 1/1

Product weight:

8 KG | 17,6 lb

With packaging:

9 KG | 19,8 lb

### **Container Table Foot 7043**

H 73 cm | 28,7"

W 43 cm | 16,9"

D 43 cm | 16,9"

Colli 1/1

Product weight:

8,5 KG | 18,7 lb

With packaging:

9,5 KG | 20,9 lb

### **Container, New Antiques 7143**

H 75 cm | 29,5"

W 45 cm | 17,7"

D 45 cm | 17,7"

Colli 1/1

Product weight:

9 KG | 19,8 lb

With packaging:

10 KG | 22 lb



---

## packaging

### Container Oval 210 top:

H 217 cm | 85.4"  
W 148 cm | 58.3"  
D 10 cm | 3.9"

Colli 1/1

Product weight:

KG | lb

With packaging:

KG | lb

### Container Oval 260 top:

H 266 cm | 104.7"  
W 177 cm | 69.7"  
D 8 cm | 3.1"

Colli 1/1

Product weight:

68 KG | 149.9 lb

With packaging:

70 KG | 154.3 lb



## Dimensions

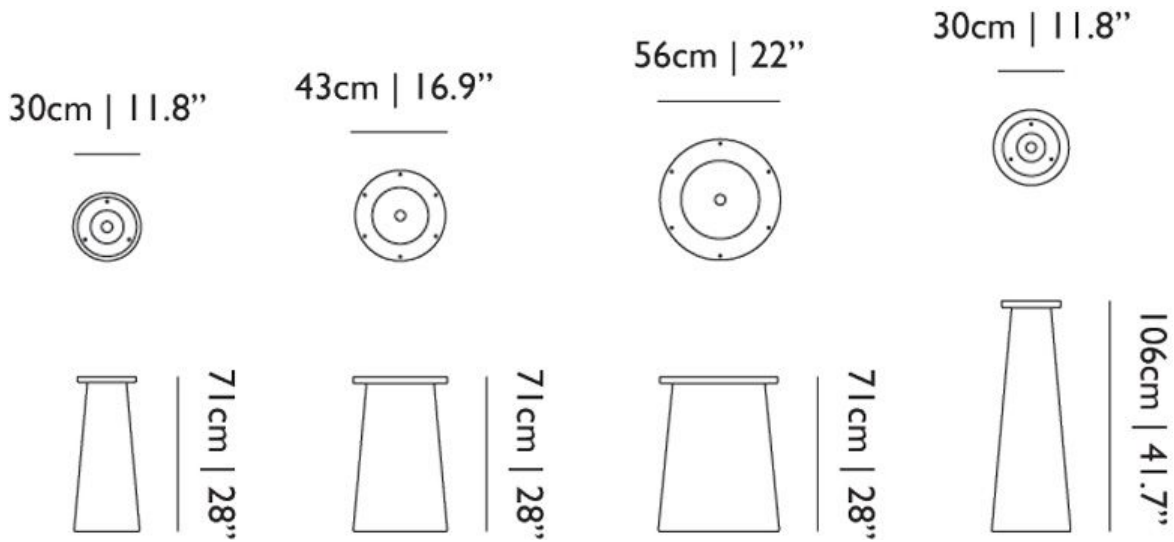

## Dimensions New Antiques

