

Matrix Otto

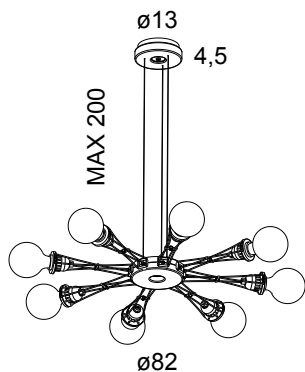

Yaacov Kaufman, 2000

Hanging lamp in aluminium alloy and steel made of a central body with eight arms that can be moved vertically; halogen or fluorescent compact bulbs can be used within the maximum admitted power.

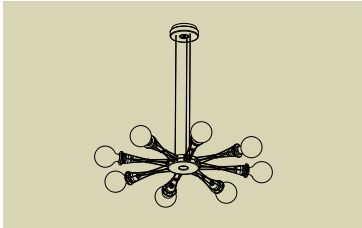
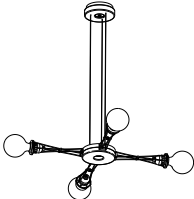
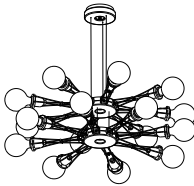
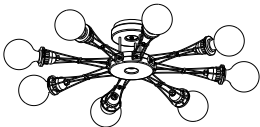
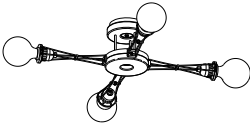

TECHNICAL DATAS	Product Name (code)	Matrix Otto (385)
	Certificates	CE
	Norms	EN 60-598-1 (CEI 34-21)
	Light sources	8 x MAX 60W - E27/E26 (not included)
	Available	230V (Europe) - 120V (USA - Japan) - 240V (UK)
	Insulation Class	I
	Protection Class	IP20
Packaging	0,058m³ - 4,0Kg	

COLOURS		
	Black	Brushed Nickel

FAMILY			
	Matrix Otto	Matrix Quattro	Matrix Doppia
			
	Matrix Otto/P	Matrix Quattro/P	Matrix Mono