



safretti®

SET THE *Mood*...



A close-up photograph of a metal bar, likely made of stainless steel, with the brand name "safretti®" engraved on its surface. The bar is positioned horizontally and is surrounded by bright, orange and yellow flames that appear to be rising from it, suggesting it is being heated or used in a high-temperature environment. The lighting is dramatic, with the flames providing the primary light source, casting a warm glow on the metal and creating deep shadows. The background is dark, making the glowing metal and flames stand out prominently.

safretti®

Safretti® designs and fabricates sustainable design eco-fireplaces. Not in a production line, but on the basis of pure craftsmanship. And we are led in this by our desire to innovate. Safretti® breaks through customary production processes and takes a second look at materials and their possible applications. A simple philosophy, but one that has proven very successful. Agents, distributors and retailers worldwide are lining up to strengthen their end users identity with Safretti® designs.

Safretti® decorative fireplaces have a unique design and a high-quality finish. A combination of exclusive design and the warmth of fire. The decorative fireplaces are easy to attach to the wall or to place in open spaces. The open fire will be created by using a special liquid (bio-alcohol). A flue is not necessary.

Due to the high-quality materials used, these fireplaces are suitable for use both inside and outside on the patio or balcony. Safretti® stands for Stylish, Modern, Trustworthy and Design.

For people with passion for exclusivity.



SET THE *Mood...*

- burns eco-friendly fuel (bio-alcohol)
- no chimney necessary
- real flames
- clean burning: no smoke, smell, soot or residue
- simple installation
- award-winning designs
- no electricity
- certified by official external institutes
- made in Holland



Cubico, design by Jan des Bouvrie

Cubico

The name says it all: for many years, the cubistic design was characteristic for the designs of Jan des Bouvrie. The Cubico is a real fireplace with atmosphere. Lovely, because the flickering flames can be seen from any angle. And ideal for sitting nicely around fire. The Cubico is the burning heart of any room.

Jan des Bouvrie.





Riviera, design by Jort Mercuur



Riviera

The Riviera is as simple as it is effective. Designer Jort Mercurur strives for the maximum effect with a minimalistic approach. Riviera designs look just like they are meant to: clean, timeless and perfectly finished. It is the floating and dancing flames that form the mysterious part.





Prometheus, design by Frans Schrofer

Prometheus

The design of the Prometheus has been approached with the eye of an expressive artist. It thus creates a combination of natural forms, poetry and rhythm. The Prometheus combines both convex and concave aluminium. The fireplace has been named after the Greek god who stole fire from the gods and then offered it as a gift to mankind. The round model thus associates with the feeling of 'wanting to share', according to Frans Schrofer.

Schrofer





Gaya, design by Roderick Vos

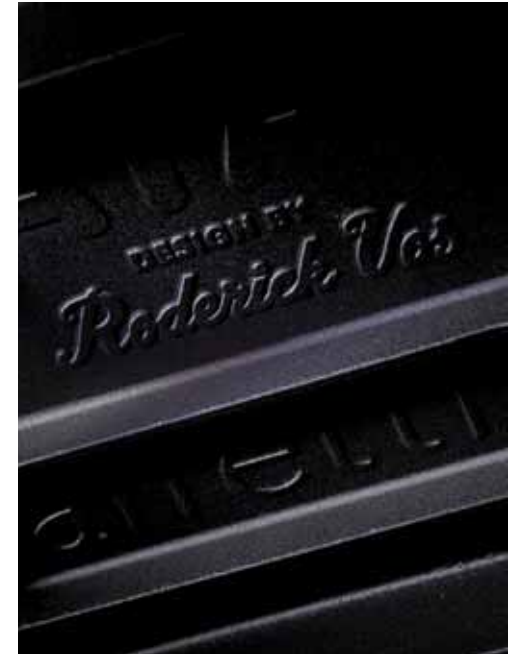

Gaya

The Gaya, designed by Roderick Vos, has a unique design. It is like a painting on the wall, which at first notice, does not appear as a fireplace. Even when the Gaya is not being used, it is obviously a nice looking object for the interior. The alienated image of fire, captured in a framed black painting, makes this design of the Gaya fantastic. It is a design that has been reduced to pure 'simplicity'.





Curva, design by Jan des Bouvrie

Curva

'Learning to look is the foundation for learning for live', according to Jan des Bouvrie, the man who has spent a lifetime taking interiors 'out of mothballs'. His obstinate, but consistent views on fire, colours, form and space have had a great influence on contemporary design of the Curva. Using the round shapes makes this fireplace more sexy. A revolutionary design with a wink to the '60's.

Jan des Bouvrie.





Carré, design by Jan des Bouvrie

Carré



'I have designed a new collection of fireplaces specially for Safretti that will add an extra dimension to the interior thanks to their simplicity and the interplay of lines'.

Jean des Bourvill.



Nemo, design by Henk Heres

Nemo

Designer Henk Heres is an expert in designing cupboards. And his puritan design Nemo is the logical consequence of this. The size of the Nemo is so well thought-out that it is one with the cupboard in which it is placed. Nemo is the universal solution and as a result of its size it can be used in almost any fitted cupboard.





Double Vision, design by Jan des Bouvrie

Double Vision

'Peace and harmony are the absolute key elements of my designs. Designs that in an interior will provide a timeless basis to work with. This specific design is a beautiful symbiosis between two products, each of which strengthens the other with force'.

Jean des Bouvies.





Cube, design by Jan des Bouvrie

Cube

As a column, standing completely free or as a single block on the floor. Jan des Bouvrie has designed a timeless, versatile fireplace, having returned to the essence of everything. The Cube is a unity of simplicity, emotion and warmth.

Jan des Bouvrie.

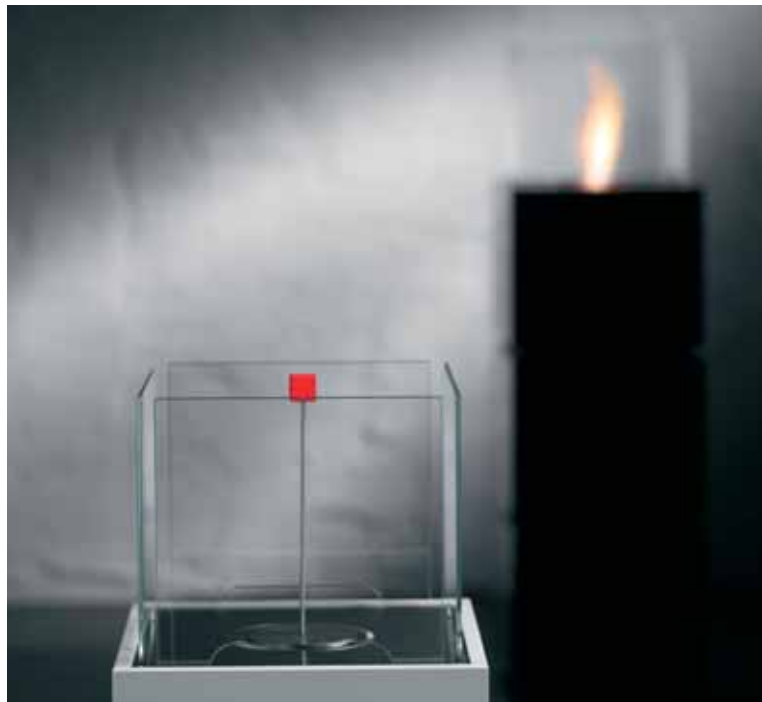



OlympiQ, design by Frans Schrofer

OlympiQ

Powered by: **PHILIPS**
sense and simplicity

With the OlympiQ you can take the outdoor life to a new level. One in which stylish design, culinary delights and a comfortable atmosphere all come together. The philosophy behind the design of the OlympiQ revolves around the combination of maximum user-friendliness and an aesthetically pleasing appearance. The result is a high-quality, modern design that makes reference to the famous Olympic torch. The OlympiQ is built around the Philips "Woodstove", a high efficiency wood burn (Philips) technology, originally intended for rural populations in India and Africa.

Salmah

The eco-friendly barbecue.



A good design is not only pleasing to the eye, but also practical.



Designers



Jan des Bouvrie (1942)

Completed his education at the Rietveld Academy. Now, he owns a leading interior design institute with its own design studio. Des Bouvrie's designs have earned countless prizes and decorations.



Frans Schrofer (1956)

Graduated from the Design Academy in Eindhoven. His international trademark is designing contemporary furniture with a twist. "Hands-on Design creates Tools for Living" remains the guiding principle for the way in which Studio Schrofer operates.



Henk Heres (1960)

After his study at the Academy of Arts in Utrecht (1984), Henk Heres was a teacher and founded his own design bureau Henk Heres Design. For national and international companies he designed sofas, box springs, cabinets, dining tables and chairs, carpets and fabrics.

**'Design is no varnish,
it is the heart and
soul of the product.'**

Tom Peters



Roderick Vos (1965)

Studied at the Design Academy in Eindhoven. Gained work experience at Ingo Maurer in Munich and Kenji Ekuan in Tokyo. Since 2004, he has focussed entirely on product design in the fortified city of Heusden in Brabant.



Jort Mercur (1967)

After finishing his education, Jort started his own company Mercursteen. Jort Mercur was responsible as well for the furnishing of the museum Belvedere in Heerenveen (the Netherlands) with self-designed aluminium furniture.



Hugo de Ruiter (1959)

“(E)Motion in form and function is my favourite design tool. Furniture and interior products are like a third skin, it should fit you in many ways.” Hugo graduated at the Design Academy in Eindhoven. He worked several years for Leolux as designer and design manager. In 2001 he started his own design office in Eindhoven.



Porsche Design Studio (1972)

All of the Porsche Design Studio’s work is distinguished by clarity and functionality of form, careful selection of materials, and high-quality workmanship that combines traditional craftsmanship with state-of-the-art technology. Since its foundation in 1972 the studio stands for the distinctive, timeless and unmistakable design signature that characterizes all of the Porsche Design Group’s products.

Awards





Safretti® wins the 'North Sea Pearl 2008 Award' for the fireplace Prometheus.
Design by Frans Schrofer.



Safretti® wins the prestigious 'GOOD DESIGN™ Award 2008' for the fireplace Gaya.
Design by Roderick Vos.



Safretti® wins the highest official 'Design Award' of the Federal Republic of Germany 2010 for the fireplace Gaya.
Design by Roderick Vos.



Safretti® wins the prestigious 'GOOD DESIGN™ Award 2010' for the fireplace / eco-friendly barbecue OlympiQ.
Design by Frans Schrofer.



Safretti® wins the Interior 'Innovation Award 2011' for the fireplace / eco-friendly barbecue OlympiQ.
Design by Frans Schrofer.

Burning system



Burning box

The casing of the burning box is glassblasted, the topside and cover are brushed. The set contains a lighter and a funnel. The rectangular burning box is also available separately.

- Material burner:** Brushed stainless steel.
- Material cover:** Brushed stainless steel.
- Details burner:** Removable, capacity 2 litres, burning time 6-8 hours.

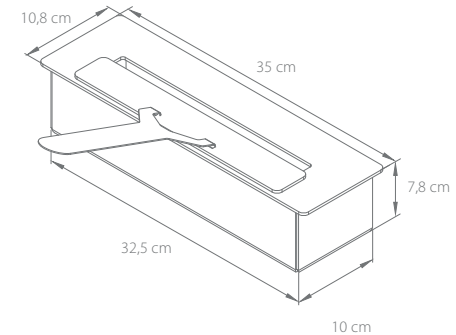

Bio-alcohol

All Safretti® fireplaces are fuelled by a renewable energy source called "bio-alcohol". Bio-alcohol, formally named "ethanol or ethyl alcohol" is an absolute alcohol, produced by the fermentation of sugars originating from agricultural and forestry products mainly sugar cane, potatoes, bananas, beetroot and recently from cereals such as wheat.

In accordance with various global regulations ethanol is a 100% alcohol which cannot be sold in its purest form to avoid human consumption. Ethanol producers denature ethanol with various substances so it can be sold. Bio-alcohol (denatured ethanol) is made up entirely of biological products resulting in a neutral ecological balance (greenhouse compliant).

The combustion of bio-alcohol results in a clean emission: heat, steam and carbon dioxide. Bio-alcohol burns just as cleanly. The initiative of using bio-alcohol or denatured ethanol as an energy source for heating is unique on the market.



Accessories

Glass shields

Safretti® glass shields protect your decorative fireplace from windy weather. Safretti® glass shields have been designed in a way that they become one with your Safretti® fireplace. Made of toughened glass to guarantee safety.



Cubico/Carré BL/XL

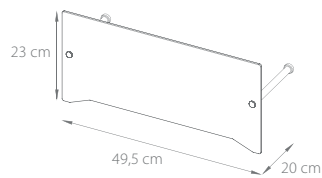

Cubico/Carré ST/XT

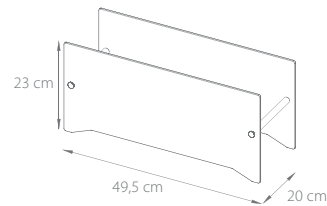

Curva BL/XL

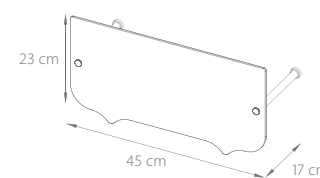

Curva ST/XT

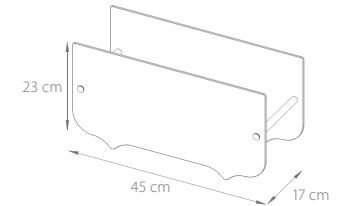

Cubico/Carré DL

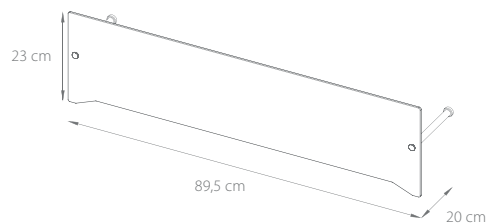

Cubico/Carré DT

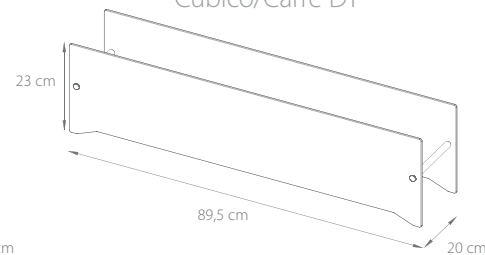

Curva DL

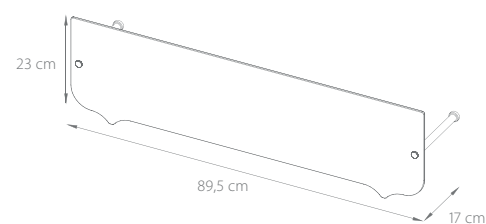

Curva DT

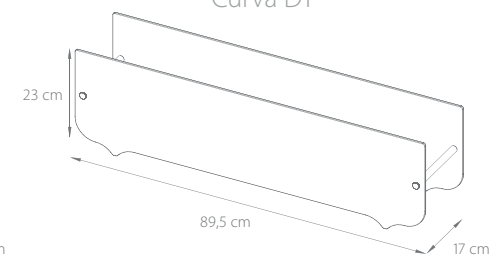

Outdoor covers

Safretti® outdoor covers have been designed to protect your Safretti® fireplace against the weather. They are made from durable materials to guarantee durability. Protective covers are available for Cubico XT, Carré XT, Curva XT, Gaya and Prometheus PB & PG.



Cubico XT / Carré XT



Curva XT



Gaya



Prometheus PB & PG

Specifications

Cubico, design by Jan des Bouvrie

Material body: Brushed stainless steel.

Material housing: Powdercoated steel.

Material burner: Brushed stainless steel.

Material cover: Brushed stainless steel.

Details burner: Removable, capacity 2 litres, burning time 6-8 hours.

Note: Cubico ST, XT and DT excluding fire resistant back.

Cubico XT includes a granite base. Cubico BL, XL and DL including fire resistant back.



Cubico ST



Cubico BL



Cubico XT



Cubico XL



Cubico DT



Cubico DL

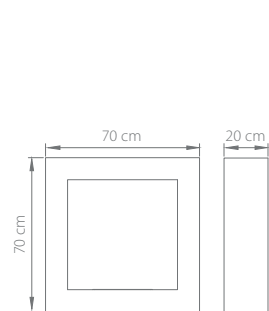

Cubico ST
Weight: 35 kg

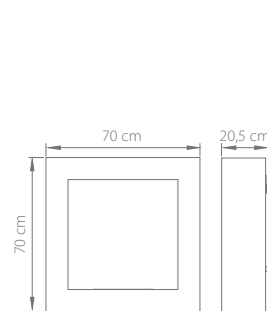

Cubico BL
Weight: 32 kg

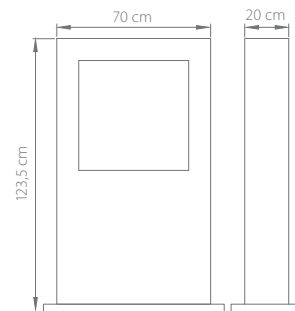

Cubico XT
Weight: 55 kg

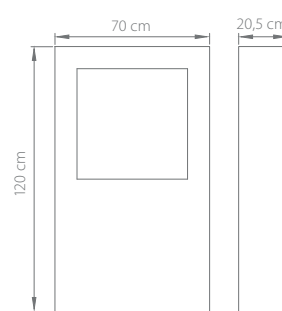

Cubico XL
Weight: 50 kg

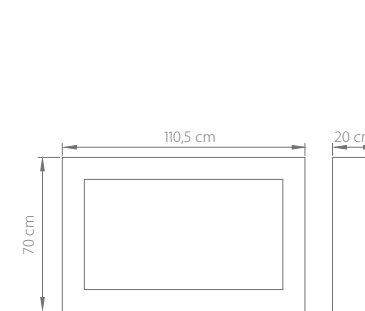

Cubico DT
Weight: 55 kg

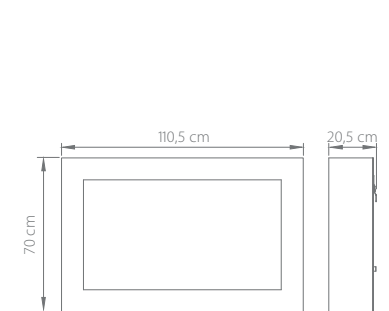

Cubico DL
Weight: 50 kg

Riviera, design by Jort Mercuur

Material tube: Brushed aluminium.

Material back: Black safety glass.

Material burner: Brushed stainless steel.

Material cover: Brushed stainless steel.

Details burner: Removable, capacity 2 litres,
burning time 6-8 hours.

Note: The Riviera LE GL contains a specially
designed burner with a capacity of 1.7 litres,
burning time 8-10 hours.



Riviera EN GL



Riviera DU GL



Riviera LE GL

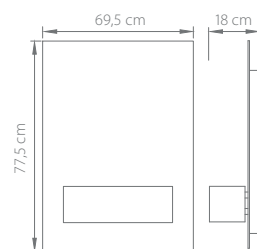

Riviera EN GL
Weight: 16 kg



Riviera DU GL
Weight: 21 kg

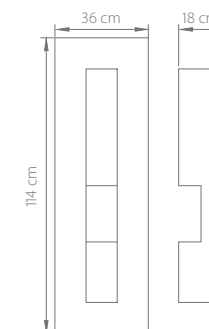

Riviera LE GL
Weight: 16 kg

Specifications

Prometheus, design by Frans Schrofer

Material body: Powdercoated aluminium.

Material burner: Brushed stainless steel.

Material cover: Brushed stainless steel.

Details burner: Removable, capacity 2 litres, burning time 6-8 hours.

Note: The Prometheus PG & PB contain a specially designed burner with a capacity of 1.7 litres, burning time 8-10 hours. Including green handle cover, optional colours available on request.

Safretti® wins the 'North Sea Pearl 2008 Award' for the fireplace Prometheus.

Design by Frans Schrofer.



Prometheus PG

Prometheus PB



Prometheus OG

Prometheus OB



Prometheus RG

Prometheus RB

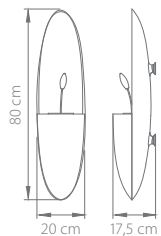

Prometheus PG & PB
Weight: 12 kg

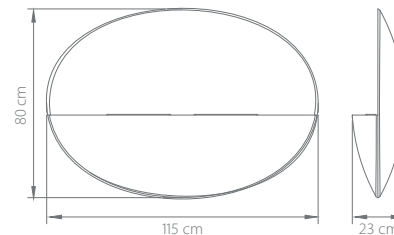

Prometheus OG & OB
Weight: 20 kg

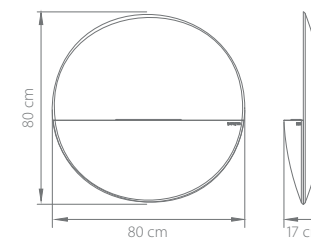

Prometheus RG & RB
Weight: 15 kg

Gaya, design by Roderick Vos

Material body: Powdercoated aluminium.

Material burner: Powdercoated aluminium.

Material cover: Powdercoated aluminium.

Details burner: Integrated burner,
capacity of 2.3 litres,
burning time 8-10 hours.

Note: Including red cover, optional colours
available on request.

Safretti® wins the prestigious 'GOOD DESIGN™ Award
2008' for the fireplace Gaya.

Design by Roderick Vos.

Safretti® wins the highest official 'Design Award' of
the Federal Republic of Germany 2010 for the
fireplace Gaya.

Design by Roderick Vos.

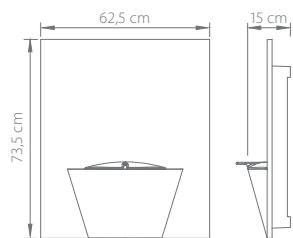

Gaya
Weight: 12 kg



Gaya



Gaya



Specifications

Curva, design by Jan des Bouvrie

Material body: Powdercoated steel.

Material housing: Powdercoated steel.

Material burner: Brushed stainless steel.

Material cover: Brushed stainless steel.

Details burner: Removable, capacity 2 litres, burning time 6-8 hours.

Note: Curva ST, XT and DT excluding fire resistant back, including powdercoated steel base. Curva BL, XL and DL including fire resistant back, excluding powdercoated steel base.



All frontpanels of the Curva models are available in two colours: white and black.



Curva ST

Curva BL



Curva XT

Curva XL



Curva DT

Curva DL

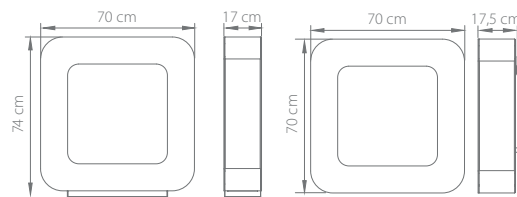

Curva ST
Weight: 35 kg

Curva BL
Weight: 32 kg

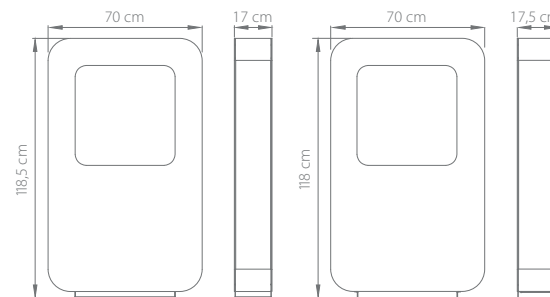

Curva XT
Weight: 55 kg

Curva XL
Weight: 50 kg

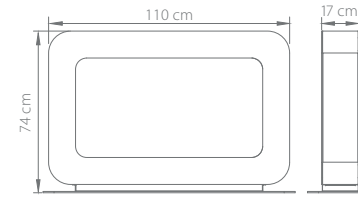

Curva DT
Weight: 55 kg

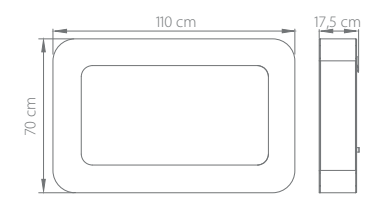

Curva DL
Weight: 50 kg

Carré, design by Jan des Bouvrie

Material body: Powdercoated steel.

Material housing: Powdercoated steel.

Material burner: Brushed stainless steel.

Material cover: Brushed stainless steel.

Details burner: Removable, capacity 2 litres, burning time 6-8 hours.

Note: Carré ST, XT and DT excluding fire resistant back.

Carré XT includes a granite base. Carré BL, XL and DL including fire resistant back.



All frontpanels of the Carré models are available in two colours: white and black.



Carré ST



Carré BL



Carré XT



Carré XL



Carré DT



Carré DL

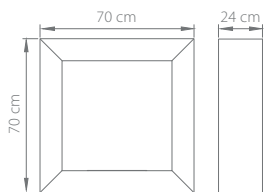

Carré ST
Weight: 35 kg

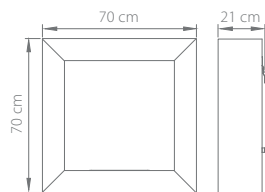

Carré BL
Weight: 32 kg

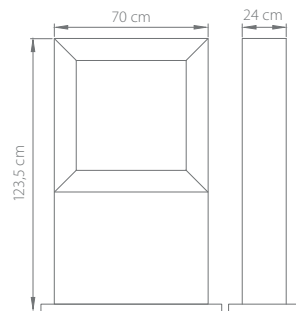

Carré XT
Weight: 55 kg

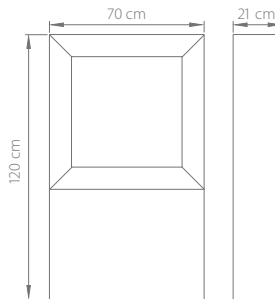

Carré XL
Weight: 50 kg



Carré DT
Weight: 55 kg



Carré DL
Weight: 50 kg

Specifications

Nemo, design by Henk Heres

Material body: Powdercoated steel.

Material housing: Powdercoated steel.

Material burner: Brushed stainless steel.

Material cover: Brushed stainless steel.

Details burner: Removable, capacity 2 litres,
burning time 6-8 hours.



All frontpanels of the Nemo models are available in two colours: white and black.



Nemo FW



Nemo FB

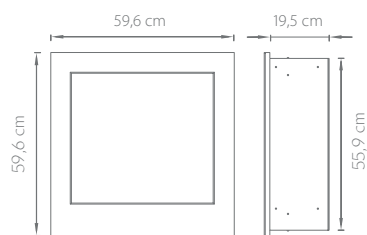

Nemo
Weight: 28 kg

Double Vision, design by Jan des Bouvrie

Material body: Powdercoated aluminium.

Material housing: Powdercoated aluminium.

Material burner: Brushed stainless steel.

Material cover: Brushed stainless steel.

Details burner: Removable, capacity 2 litres,
burning time 6-8 hours.



All frontpanels of the Double Vision models are available in black glass, white glass and Magic Mirror glass.

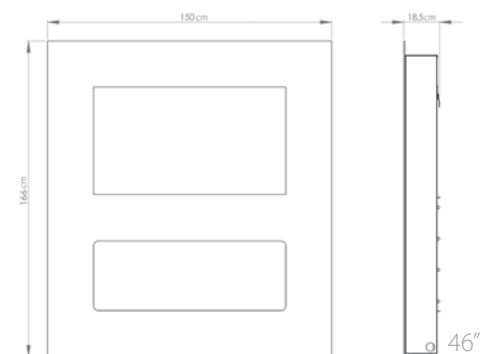

Double Vision White



Double Vision Black



Double Vision Magic Mirror

Specifications

Cube, design by Jan des Bouvrie

Material body: Nature stone.

Material burner: Brushed stainless steel.

Material cover: Brushed stainless steel.

Details burner: Removable, capacity 2 litres,
burning time 8-10 hours.



Body of the Cube is available in two colours:
white and black.

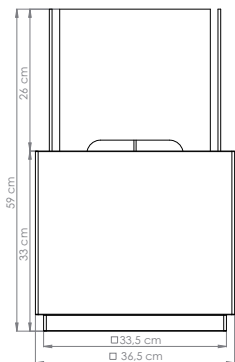

Cube W0



Cube B0



Cube W1



Cube W2



Cube B3



Specifications

OlympiQ, design by Frans Schrofer

Material body: Powdercoated aluminium.

Material burner(s): Brushed stainless steel.

Material cover: Brushed stainless steel.

Details ethanol burner: Removable, capacity 2 litres, burning time 6-8 hours.

Details Woodstove: Removable, generated outputpower is 5 kW.

Details wok: Teflonized aluminium.

Details hotplate: Teflonized aluminium.

Note: The OlympiQ as a fireplace contains a glass tube. The OlympiQ also includes the Philips Woodstove, wok and hotplate for cooking outside.

Powered by: **PHILIPS**
sense and simplicity

Safretti® wins the prestigious 'GOOD DESIGN™ Award 2010' for the fireplace / eco-friendly barbecue OlympiQ. Design by Frans Schrofer.

Safretti® wins the Interior 'Innovation Award 2011' for the fireplace / eco-friendly barbecue OlympiQ.

Design by Frans Schrofer.

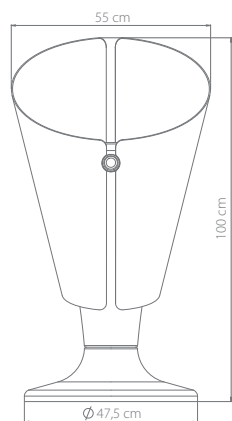

Flames



Wok



Hotplate, grill side

The OlympiQ from hotplate* to fireplace →



*grill side

← The OlympiQ from fireplace to hotplate*

Preparing the fireplace

1. Remove the top plate from the OlympiQ.
2. Remove the Woodstove from the OlympiQ.
3. Place the top plate back in position.
4. Place the ethanol-burner inside the top plate of the OlympiQ.
5. Light the ethanol with the lighter provided.

Preparing the hotplate and wok

1. Place the charged Woodstove in the OlympiQ.
2. Place the top plate back in position.
3. Put some small pieces of dry wood inside the burning chamber and light the fire.
Do not fill the chamber more than halfway. There may be a little smoke at first.
When the wood catches fire, switch on the appliance, the blue light will go on.
4. Place the grill plate or wok on the OlympiQ's stands. Turn the red knob to adjust the level of heat.



www.safretti.com safretti®

safretti®

Metaalstraat 3a/3c | 7483 PD Haaksbergen (NL) | T. +31 (0)53 574 25 54 | F. +31 (0)53 574 34 53 | E. info@safretti.com | I. www.safretti.com